

KSTRONG[®]
UNRIVALED SAFETY.

2023
Q1 - MINI CATALOG



SELF-RETRACTING LIFELINES

KStrong offers a full range of self-retracting lifeline solutions to meet nearly every user requirement and for a wide variety of applications. Whether the user is working in construction, utilities maintenance or general industry and the installation is overhead at foot-level or personally attached to the harness, Micron™ and BRUTE™ SRLs provide durable performance and reliability that's supported with 3rd-party testing documentation to meet all applicable industry standards.

MICRON™ SRL SERIES

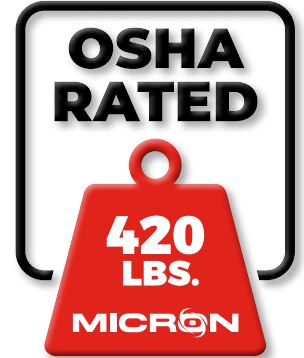

Micron™ SRL Series | Personal

Class
1
Anchor at or
above dorsal D-ring

Class
1
Anchor at or
above dorsal D-ring

Class
1
Anchor at or
above dorsal D-ring

Class
1
Anchor at or
above dorsal D-ring

Class
1
Anchor at or
above dorsal D-ring



SELF-RETRACTING LIFELINES



Class 1
Anchor at or above dorsal D-ring



Class 1
Anchor at or above dorsal D-ring



Class 1
Anchor at or above dorsal D-ring



Class 1
Anchor at or above dorsal D-ring



Class 1
Anchor at or above dorsal D-ring



	Model	Length	Description	Class
	A	UFS350002	6ft. Steel Snap Hook; comes with locking carabiner UFC401101	1
	B	UFS350002D	6ft. Twin Model - Steel Snap Hook; comes with UFC409151	1
	C	UFS351102	6ft. Aluminum Carabiner; comes with locking carabiner UFC401101	1
	D	UFS351102D	6ft. Twin Model - Aluminum Carabiner; comes with UFC409151	1
	E	UFS354002	6ft. Steel Rebar Hook; comes with locking carabiner UFC401101	1
	F	UFS354002D	6ft. Twin Model - Steel Rebar Hook; comes with UFC409151	1
	G	UFS356002	6ft. Aluminum Rebar Hook w/Steel ANSI Gate; comes with locking carabiner UFC401101	1
	H	UFS356002D	6ft. Twin Model - Aluminum Rebar Hook w/Steel ANSI Gate; comes with UFC409151	1
	J	UFS359002	9ft. Tie-back Hook; comes with locking carabiner UFC401101	1
	K	UFS359002D	9ft. Twin Model - Tie-back Hook; comes with UFC409151	1
	L	UFC409151	Twin/Single Connector (Steel Pin)	

Note: While supplies last, Class A/B still available on some models.

SELF-RETRACTING LIFELINES

BRUTE™ SRL Series - Wire Cable | Overhead

Model	Length	Cable Type	Attachment End	Installation Carabiner	Class
A UFS330008	8ft.	Stainless Steel	Snap Hook	UFC401101	1
B UFS310010	10ft.	Steel	Snap Hook	UFC401101	1
C UFS310020	20ft.	Steel	Snap Hook	UFC401101	1
C UFS310020(SS)	20ft.	Stainless Steel	Snap Hook	UFC401101	1
D UFS310030	30ft.	Steel	Snap Hook	UFC401101	1
D UFS310030(SS)	30ft.	Stainless Steel	Snap Hook	UFC401101	1
E UFS310050	50ft.	Steel	Snap Hook	UFC401101	1
E UFS310050(SS)	50ft.	Stainless Steel	Snap Hook	UFC401101	1
F UFS310100	100ft.	Steel	Snap Hook	UFC401101	1

Note: While supplies last, Class A/B still available on some models.

BRUTE™

SRL SERIES - WIRE CABLE



SELF-RETRACTING LIFELINES

BRUTE™ & BRUTE-AL™ SRL Series - Wire Cable | Overhead

Model	Length	Cable Type	Case	Attachment End	Installation Carabiner	Tag Line	Class	
G	UFS310130	30ft.	Steel	Polymer	Carabiner	UFC401101	Included	1
H	UFS310150	50ft.	Steel	Polymer	Carabiner	UFC401101	Included	1
J	UFS480020	20ft.	Steel	Aluminum	Snap Hook	UFC401101	Included	1
K	UFS480030	30ft.	Steel	Aluminum	Snap Hook	UFC401101	Included	1
L	UFS480050	50ft.	Steel	Aluminum	Snap Hook	UFC401101	Included	1



UFC401101 Carabiners included with every BRUTE™ SRL and SRL-LE. Tag Lines also included for all models 18ft. and longer.

Note: While supplies last, Class A/B still available on some models.

BRUTE™

SRL SERIES - WIRE CABLE

BRUTE™ AL™

SRL SERIES ALUMINUM™

Rugged Durable Aluminum Housing



Class
1
Anchor at or above dorsal D-ring

Class
1
Anchor at or above dorsal D-ring



Class
1
Anchor at or above dorsal D-ring

Class
1
Anchor at or above dorsal D-ring

Class
1
Anchor at or above dorsal D-ring

SELF-RETRACTING LIFELINES

BRUTE™ SRL Series - Web | Overhead

Model	Length	Cable Type	Attachment End	Installation Carabiner	Tag Line	Class
A UFS350011	11 ft.	Webbing	Snap Hook	UFC401101		1
B UFS350025	25 ft.	Webbing	Snap Hook	UFC401101	Included	1

Note: While supplies last, Class A/B still available on some models.

BRUTE™

SRL SERIES - WEB



A

Class
1
Anchor at or
above dorsal D-ring



B

Class
1
Anchor at or
above dorsal D-ring



UFC401101 Carabiners included with every BRUTE™ SRL and SRL-LE. Tag Lines also included for all models 18ft. and longer.

SELF-RETRACTING LIFELINES

BRUTE™ SRL Series - Web | Personal

Model	Length	Lifeline	Attachment End	Installation Carabiner	Class
C UFS359506	8ft.	Hi-Abrasion Resistant Dyneema Web	Tie-back Hook	UFC409151	1
D UFS359506D	Twin 8ft.	Hi-Abrasion Resistant Dyneema Web	Tie-back Hooks	UFC409151	1

Note: While supplies last, Class A/B still available on some models.

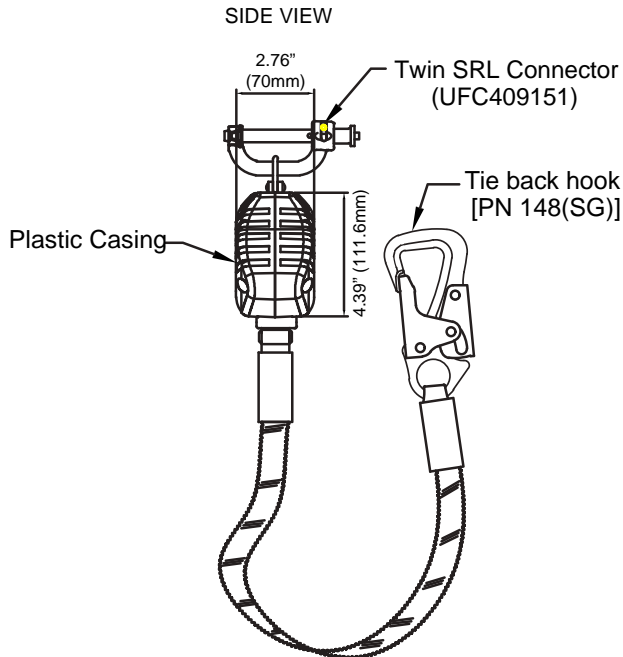
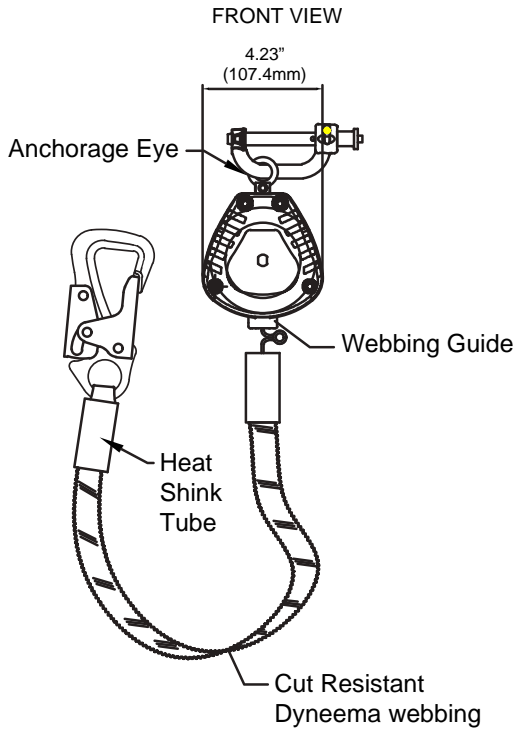

Meets or Exceeds ANSI Z359.14-2014 Class B

*Arriving Q1-2023

SELF-RETRACTING LIFELINES

BRUTE™ LE SRL Series | Leading Edge (LE) Rated



	Model	Length	Installation Carabiner	Tag Line	Class
A	UFS310018L	18ft.	UFC401101	Included	2
B	UFS310025L	25ft.	UFC401101	Included	2
C	UFS310050L	50ft.	UFC401101	Included	2
D	UFS310080L	80ft.	UFC401101	Included	2

Note: While supplies last, Class A/B still available on some models.



UFC401101 Carabiners included with every BRUTE™ SRL and SRL-LE. Tag Lines also included for all models 18ft. and longer.

SELF-RETRACTING LIFELINES

BRUTE-AL™ LE SRL Series

Leading Edge (LE) Rated

Rugged Durable Aluminum Housing



Class 2
Anchor above or below dorsal D-ring

Class 2
Anchor above or below dorsal D-ring

Class 2
Anchor above or below dorsal D-ring

Model	Length	Installation Carabiner	Tag Line	Class
E UFS480020L	20ft. LE	UFC401101	Included	2
F UFS480025L	25ft. LE	UFC401101	Included	2
G UFS480050L	50ft. LE	UFC401101	Included	2

Note: While supplies last, Class A/B still available on some models.



UFC401101 Carabiners included with every BRUTE™ SRL and SRL-LE. Tag Lines also included for all models 18ft. and longer.

SELF-RETRACTING LIFELINES

BRUTE Backer™ LE SRL Series | Leading Edge (LE) Rated

BRUTE™
BACKER™ **LE**
WE'VE GOT YOUR BACK.



Class 2
Anchor above or below dorsal D-ring



Class 2
Anchor above or below dorsal D-ring



Class 2
Anchor above or below dorsal D-ring



Class 2
Anchor above or below dorsal D-ring

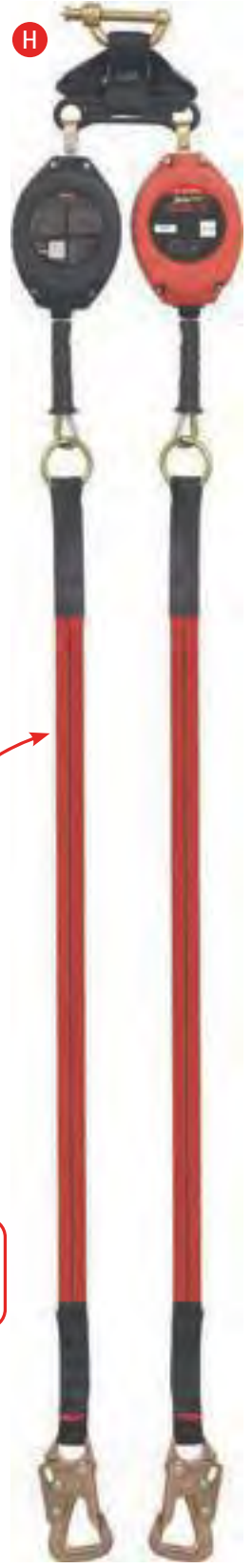

Class 2
Anchor above or below dorsal D-ring

Tie-Back Webbing

SELF-RETRACTING LIFELINES

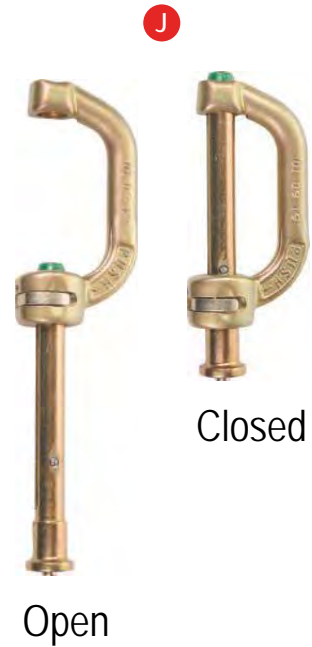

Class 2
Anchor above or below dorsal D-ring

Class 2
Anchor above or below dorsal D-ring

Class 2
Anchor above or below dorsal D-ring

Model	Length	Description	Class
A	UFS310206L	8.5ft. Steel Snap Hook; comes with locking carabiner UFC401101	2
B	UFS310206LD	8.5ft. Twin Model - Steel Snap Hook; comes with UFC409151	2
C	UFS314006L	8.5ft. Steel Rebar Hook; comes with locking carabiner UFC401101	2
D	UFS314006LD	8.5ft. Twin Model - Steel Rebar Hook; comes with UFC409151	2
E	UFS316106L	8.5ft. Aluminum Rebar Hook; comes with locking carabiner UFC401101	2
F	UFS316106LD	8.5ft. Twin Model - Aluminum Rebar Hook; comes with UFC409151	2
G	UFS319006L	8.5ft. Tie-back Hook; comes with locking carabiner UFC401101	2
H	UFS319006LD	8.5ft. Twin Model - Tie-back Hook; comes with UFC409151	2
J	UFC409151	Twin/Single Connector (Steel Pin)	

Note: While supplies last, Class A/B still available on some models.



SELF-RETRACTING LIFELINES

BRUTE™ Sealed Series | Sealed Block SRL's (IP68 Level of IEC 60529) with Stainless Steel Cable and Snap Hook

BRUTE™ SEALED SERIES



**IP68 Level
of IEC 60529**

Class
1
Anchor at or
above dorsal D-ring

Class
1
Anchor at or
above dorsal D-ring

	Model	Length	Class
G	UFS570030	30ft.	1
H	UFS570060	60ft.	1
Not Shown	UFS5700100*	100ft.	1

Note: While supplies last, Class A/B still available on some models.



Stainless Steel Carabiners included with every BRUTE™ Sealed SRL. Tag Lines also included.

KStrong® New SRL ANSI Standard

New ANSI Standards for Fall Protection SRLs

ANSI/ASSP Z359.14-2021 standard has been recently updated to minimize confusion in the market as to proper use of Self-Retracting Lifelines (SRLs) in relation to anchor height requirements. Beginning in April 2022, KStrong will begin transitioning manufacturing of SRLs from current ANSI Class A/Class B to the new Class 1/Class 2 standard. However, given the manufacturing, testing, and messaging associated with the new standard, the effective compliance date has been pushed back to February 2023.

Classification Changes

SRLs will now be classified by two new class ranges: Class 1 and Class 2. The table below identifies Class 1 SRLs that are only to be used only on overhead anchorages and are subjected to a max free fall of 2 feet or less. Class 2 SRLs can only be used in applications where overhead anchorages may not be accessible and a structural edge is used instead; these can withstand a free fall of no more than 6 feet over an edge.

ANSI Z359.14-2014 (Old)	ANSI Z359.14-2021 (New)
Class A -Tested overhead with 282 lb. weight -Must arrest fall within 24" -Average force less than 1,350lbs.	Class 1 -Tested overhead with 310 lb. weight -Must arrest fall within 42" -Average force less than 1,350lbs.
Class B -Tested overhead with 282 lb. weight -Must arrest fall within 54" -Average force less than 900lbs.	Class 2 -Meets Class 1 standards -Tested at foot level with 310 lb. weight -Arrest distance printed on label and instructions

SRLs must have Class 1 or Class 2 clearly labeled on the product as per the image below.

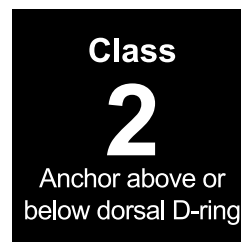
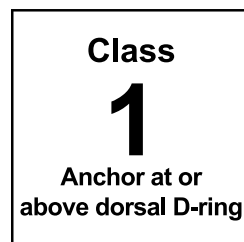

Also included in the ANSI Z359.14-2021 standard are testing requirements for a SRL-P, which is a self-retracting lanyard worn by the user on a full-body harness to be used as a fall arrest connector. Standard specifics are detailed in the table below.

As the new Class 1 and Class 2 KStrong products arrive in the United States, we will be sure to keep you updated on availability.

BODY WEAR

When it comes to your fall protection equipment, a full-body harness is the single most important equipment choice you can make for your crew. While KStrong harnesses are built to meet or exceed ANSI standards and OSHA regulations, we've also designed comfort, lumbar support, positioning rings and accessibility into our body wear with continued freedom of movement, sustained safety and improved productivity for workers at height. KStrong harnesses provide workers with confidence, which directly affects the user's productivity. While many of our safety harnesses can be used on most jobs, we also manufacture innovative full-body harnesses for specific uses within different industries.

KAPTURE™ HARNESS SERIES

Kapture™ Essential | 3-point Adjustment | Available Sizes: Universal (S-L), L-XL

KAPTURE™ ESSENTIAL
LV1 || FULL BODY HARNESS

UFH10101G | Tongue Buckle Legs



UFH16101G | Removable Shoulder Padding

UFH10101P | Pass-Thru Legs



Kapture™ Essential | 3-point Adjustment | Available Sizes: Universal (S-L), L-XL

KAPTURE™ ESSENTIAL
LV1 || FULL BODY HARNESS

UFH10131G | Tongue Buckle Legs & Side D-Rings



UFH10131P | Pass-Thru Legs & Side D-Rings



BODY WEAR

Kapture™ Essential | 3-point Adjustment | Available Sizes: Universal (S-L), L-XL

KAPTURE™ ESSENTIAL
LV1 || FULL BODY HARNESS

UFH10102G | Tongue Buckle Legs, Dorsal D-Ring with Sewn In 18" Extension O-Ring



UFH10102P | Pass-Thru Legs, Dorsal D-Ring with Sewn In 18" Extension O-Ring



Kapture™ Essential+ | 5-point Adjustment | Available Sizes: S-M, M-L, L-XL, XL-2XL

KAPTURE™ +PLUS
LV1 || ESSENTIAL

UFH16201GP | Tongue Buckle Legs & with Removable Back/Shoulder Pad



UFH16231GP | Back/Shoulder Pad and Waist Belt, 3 D-rings, Tongue Buckle Legs



BODY WEAR

Kapture™ Elite | 5-point Adjustment | Available Sizes: S-M, M-L, L-XL, XL-2XL, 2XL-3XL

UFH10201G | Tongue Buckle Legs

KAPTURE™ ELITE
LV2 || FULL BODY HARNESS



Kapture™ Elite | 5-point Adjustment | Available Sizes: S-M, M-L, L-XL

UFH10201P | Pass-Thru Legs



Kapture™ Elite | 5-point Adjustment | Available Sizes: S-M, M-L, L-XL

UFH10231G | Tongue Buckle Legs & Side D-Rings

KAPTURE™ ELITE
LV2 || FULL BODY HARNESS



UFH10231P | Pass-Thru Legs & Side D-Rings



BODY WEAR

Kapture™ Elite | 5-point Adjustment | Available Sizes: S-M, M-L, L-XL, XL-2XL, 2XL-3XL

KAPTURE™ ELITE
LV2 || FULL BODY HARNESS

UFH10211G | Front D-Ring, Tongue Buckle Legs



UFH10241G | Front D-Ring, Shoulder D-rings, Tongue Buckle Legs | Available Sizes: S-M, M-L, L-XL, XL-2XL



UFH10211P* | Front D-Ring, Pass-Thru Legs



Kapture™ Elite | 5-point Adjustment | Available Sizes: S-M, M-L, L-XL

KAPTURE™ ELITE
LV2 || FULL BODY HARNESS

UFH10251G | Climbing FBH, TB Legs, Front & Side D-rings



UFH10251P | Climbing FBH, PT Legs, Front & Side D-rings



BODY WEAR

Kapture™ Elite | 5-point Adjustment | Available Sizes: S-M, M-L, L-XL, XL-2XL, 2XL-3XL

UFH10252P* | Pass-Thru Legs, Front & Side D-rings

KAPTURE™ ELITE
LV2 || FULL BODY HARNESS



Kapture™ Elite | 5-point Adjustment | Available Sizes: S-M, M-L, L-XL, XL-2XL

UFH10261G* | Tongue Buckle Legs, Front, Side, and Shoulder D-rings



Harness Accessories

UFZ850100 | Trauma Step-Up Relief; Retrofits to Most Harnesses



Instructional Video
Scan with camera to view a quick and informative safety video on this product.



BODY WEAR

Harness Accessories

UFZ800100 | 18' Clear Pack SAL with snap hook and D-ring



UFZ802001 | 18' Lanyard extender with snap hook, other end O-ring



UFZ800501* | 20' D-ring extender with loop, other end D-ring



UFZ802011C | D-ring Extender with Carabiner and O-Ring



Harness Accessories

UFZ801001 | Removable Shoulder Yoke Comfort Pad for use with full body harnesses



UFZ800200* | Replacement Lanyard Keeper with Large Ring



UFZ200101* | Kit Bag - Small



Harness Accessories

UFZ801011 | 54" Removable Tool Belt



UFZ801012 | 60" Removable Tool Belt



Belt & Leg Strap Sizing

Harness Size	Waist Circumference (in.)	Leg Circumference (in.)
Small - Medium	*Belt not provided in this size	24 - 37
Medium - Large	*Belt not provided in this size	24 - 39
Universal (Small - Large)	33 - 46	27 - 42
Large - X-Large	33 - 49	27 - 43
X-Large - 2X-Large	33 - 50	27 - 45

*Arriving Q1-2023

Kapture™ Elite+ Harnesses featuring **D-Ring Plus™**



Step 1:



Open Dual Connector.

Step 2:



Insert Dual Connector into D-Ring Plus™.

Step 3:



Fully close/lock Dual Connector.

Step 4:



Fast, easy, and safe. You're all finished.

Kapture™ Elite+ | 5-point Adjustment, Shoulder/Back Pad | Available Sizes: S-M, M-L, L-XL, XL-2XL

Kapture™ Elite+ | 5-point Adjustment, Shoulder/Back Pad | Available Sizes: S-M, M-L, L-XL, XL-2XL

UFH15201GQ | Tongue Buckle Legs, Quick Connect Chest, Enhanced Dorsal D-ring

UFZ850100 Trauma Relief Straps Included

KAPTURE™
LV2 || ELITE
+PLUS



UFH15203GQ | Spring Torso Adjusters, Enhanced Aluminum Dorsal D-ring Plus, Quick Connect Chest, Multi-Flex Feature for Ease of Mobility, Tongue Buckle Legs

UFZ850100 Trauma Relief Straps Included

KAPTURE™
LV2 || ELITE
+PLUS



BODY WEAR

Kapture™ Elite+ | 5-point Adjustment, Comfort Shoulder/Back Pad | Available Sizes: S-M, M-L, L-XL, XL-2XL

UFH152011GQ | Front D-Ring, Tongue Buckle Legs, Quick Connect Chest

UFH15201Q | Quick Connect Chest and Leg Buckles

KAPTURE™
LV2 || ELITE
+PLUS



UFZ850100 Trauma Relief Straps Included



UFZ850100 Trauma Relief Straps Included

Kapture™ Elite+ | 5-point Adjustment, Comfort Shoulder/Back Pad | Available Sizes: S-M, M-L, L-XL, XL-2XL

UFH15231Q | Quick Connect Chest and Leg Buckles, Side D-Rings

UFH15231GQ | Quick Connect Chest, Tongue Buckle Legs, Side D-Rings

KAPTURE™
LV2 || ELITE
+PLUS



UFZ850100 Trauma Relief Straps Included



UFZ850100 Trauma Relief Straps Included

BODY WEAR

Kapture™ Epic | 5-point Adjustment, Comfort Back Pad & Belt | Available Sizes: Universal (S-L), L-XL

UFH10331G | Quick Connect Chest, Tongue Buckle Legs, Side D-rings

UFH10331P | Quick Connect Chest & Legs, Side D-rings

KAPTURE™ EPIC
LV3 || FULL BODY HARNESS

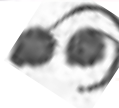

UFZ850100 Trauma Relief Straps Included

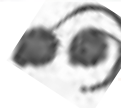

UFZ850100 Trauma Relief Straps Included

Kapture™ Epic+ | 5-point Adjustment, Comfort Back Pad & Belt | Available Sizes: S-M, M-L, L-XL, XL-2XL, 2XL-3XL

UFH10332G | Quick Connect Chest, Tongue Buckle Legs, Enhanced Dorsal D-ring Plus, Side D-rings

UFH10332P | Quick Connect Chest & Legs, Enhanced Dorsal D-ring Plus, Side D-rings

KAPTURE™ +PLUS
LV3 || EPIC

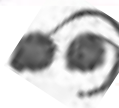

UFZ850100 Trauma Relief Straps Included

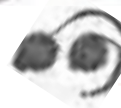

UFZ850100 Trauma Relief Straps Included

BODY WEAR

Kapture™ Epic+ | 5-point Adjustment, Comfort Back Pad & Belt | Available Sizes: S-M, M-L, L-XL, XL-2XL

UFH10341G* | Quick Connect Chest, Tongue Buckle Legs, Enhanced Dorsal D-ring Plus, Front & Side D-rings

KAPTURE™
LV3 || EPIC
+PLUS



UFZ850100 Trauma Relief Straps Included

Kapture™ Element | 5-point Adjustment, Revolta™ Oil and Water Repellent Webbing | Available Sizes: S-M, M-L, L-XL, XL-2XL

UFH10801GQ | Quick Connect Chest, Tongue Buckle Legs, Enhanced Dorsal D-ring Plus

KAPTURE™
LV4 || FULL BODY HARNESS
ELEMENT



Kapture™ Element | 5-point Adjustment, Revolta™ Oil and Water Repellent Webbing | Available Sizes: S-M, M-L, L-XL, XL-2XL

UFH10802Q* | Back/Shoulder Pad, Quick Connect Chest & Legs, Enhanced Dorsal D-ring Plus, Trauma Relief Straps

KAPTURE™
LV4 || FULL BODY HARNESS
ELEMENT



UFZ850100 Trauma Relief Straps Included

Kapture™ Element | 5-point Adjustment, Revolta™ Oil and Water Repellent Webbing | Available Sizes: S-M, M-L, L-XL, XL-2XL

UFH10811GQ* | Quick Connect Chest, Tongue Buckle Legs, Enhanced Dorsal D-ring Plus, Front D-ring

KAPTURE™
LV4 || FULL BODY HARNESS
ELEMENT



*Arriving Q1-2023

BODY WEAR

Kapture™ Element | Arc Flash Rated 5-point Adjustment | Available Sizes: Universal (S-L), L-XL

KAPTURE™ ELEMENT
LV4 II FULL BODY HARNESS

UFH10700P | Mating Buckle Legs & Chest



UFH10701P | Mating Buckle Legs & Chest, Side D-rings



Kapture™ Element | Arc Flash Rated 5-point Adjustment | Available Sizes: Universal (S-L), L-XL

KAPTURE™ ELEMENT
LV4 II FULL BODY HARNESS

UFH10710P* | Mating Buckle Legs & Chest, Front D-Ring



UFH10711P* | Mating Buckle Legs & Chest, Web Loop Dorsal and Front D-rings



BODY WEAR

Kapture™ Element | Arc Flash Rated 5-point Adjustment, Back/Shoulder Pad | Available Sizes: Universal (S-L), L-XL

KAPTURE™ ELEMENT
LV4 II FULL BODY HARNESS

UFH10731P | Padded Belt, MB Legs & Chest, Side D-rings



UFH10732P | Padded Belt, MB Legs & Chest, Front & Side D-rings



Kapture™ Belts | Padded Waist Tool Belts with D-Rings

UFZ840020 | 1 Rear Restraint D-ring with Removable Tool Belt



UFZ840010 | 2 Work Positioning Side D-rings with Removable Tool Belt



BODY WEAR

Harness Features Chart

Kapture™ Series	Model	Adjustment Points & Special Feature(s)	D-Ring Configuration	Leg Straps			Belt	Pads	Available Sizes				Minimum Standards Met	
				Pass Thru	Tongue Buckle	Quick Connect			Universal (S - L)	S - M	M - L	L - XL		XL - 2XL
Essential	UFH10101P	3	Back (Dorsal)	⚡					⚡			⚡		OSHA & ANSI Z359.11-2014
Essential	UFH10101G	3	Back (Dorsal)		⚡				⚡			⚡		OSHA & ANSI Z359.11-2014
Essential	UFH16101G	3	Back (Dorsal)		⚡			Removable Shoulders & Back	⚡			⚡		OSHA & ANSI Z359.11-2014
Essential	UFH10102P	3	Back (Dorsal) with 18" Ext. O-ring	⚡					⚡			⚡		OSHA & ANSI Z359.11-2014
Essential	UFH10102G	3	Back (Dorsal) with 18" Ext. O-ring		⚡				⚡			⚡		OSHA & ANSI Z359.11-2014
Essential	UFH10131P	3	Back (Dorsal) & Sides	⚡					⚡			⚡		OSHA & ANSI Z359.11-2014
Essential	UFH10131G	3	Back (Dorsal) & Sides		⚡				⚡			⚡		OSHA & ANSI Z359.11-2014
Essential+	UFH16201GP	5	Back (Dorsal)		⚡			Removable Shoulders & Back		⚡	⚡	⚡	⚡	OSHA & ANSI Z359.11-2014
Essential+	UFH16231GP	5	Back (Dorsal) & Sides		⚡		⚡	Shoulders & Back		⚡	⚡	⚡	⚡	OSHA & ANSI Z359.11-2014
Elite	UFH10201P	5	Back (Dorsal)	⚡						⚡	⚡	⚡		OSHA & ANSI Z359.11-2014
Elite	UFH10201G	5	Back (Dorsal)		⚡					⚡	⚡	⚡	XL-2X, 2X-3X	OSHA & ANSI Z359.11-2014
Elite	UFH10211P	5	Back (Dorsal), Front	⚡						⚡	⚡	⚡	XL-2X, 2X-3X	OSHA & ANSI Z359.11-2014
Elite	UFH10211G	5	Back (Dorsal), Front		⚡					⚡	⚡	⚡	XL-2X, 2X-3X	OSHA & ANSI Z359.11-2014
Elite	UFH10231P	5	Back (Dorsal) & Sides	⚡						⚡	⚡	⚡		OSHA & ANSI Z359.11-2014
Elite	UFH10231G	5	Back (Dorsal) & Sides		⚡					⚡	⚡	⚡		OSHA & ANSI Z359.11-2014
Elite	UFH10241G	5	Back (Dorsal), Front, Shoulder		⚡					⚡	⚡	⚡	⚡	OSHA & ANSI Z359.11-2014
Elite	UFH10251P	5, Crossover Design	Back (Dorsal), Front & Sides	⚡						⚡	⚡	⚡		OSHA & ANSI Z359.11-2014
Elite	UFH10251G	5, Crossover Design	Back (Dorsal), Front & Sides		⚡					⚡	⚡	⚡		OSHA & ANSI Z359.11-2014
Elite	UFH10252P	5	Back (Dorsal), Front & Sides	⚡						⚡	⚡	⚡	XL-2X, 2X-3X	OSHA & ANSI Z359.11-2014
Elite	UFH10261G	5	Back (Dorsal), Front, Shoulder, & Sides		⚡					⚡	⚡	⚡	⚡	OSHA & ANSI Z359.11-2014
Elite+	UFH15201GQ	5	Enhanced Back (Dorsal)		⚡	Chest		Shoulders & Back		⚡	⚡	⚡	⚡	OSHA & ANSI Z359.11-2014

*Arriving Q1-2023

BODY WEAR

Harness Features Chart

Kapture™ Series	Model	Adjustment Points & Special Feature(s)	D-Ring Configuration	Leg Straps			Belt	Pads	Available Sizes				Minimum Standards Met	
				Pass Thru	Tongue Buckle	Quick Connect			Universal (S - L)	S - M	M - L	L - XL		XL - 2XL
Elite+	UFH152011GQ	5	Enhanced Back (Dorsal), Front		⚡	Chest		Shoulders & Back		⚡	⚡	⚡	⚡	OSHA & ANSI Z359.11-2014
Elite+	UFH15201Q	5	Enhanced Back (Dorsal)			⚡ + Chest		Shoulders & Back		⚡	⚡	⚡	⚡	OSHA & ANSI Z359.11-2014
Elite+	UFH15203GQ	5, Multi-Flex, Spring Torso Adjusters	Enhanced Back (Dorsal)		⚡	Chest		Removable Shoulders & Back		⚡	⚡	⚡	⚡	OSHA & ANSI Z359.11-2014
Elite+	UFH15231Q	5	Enhanced Back (Dorsal) & Sides			⚡ + Chest		Shoulders & Back		⚡	⚡	⚡	⚡	OSHA & ANSI Z359.11-2014
Elite+	UFH15231GQ	5	Enhanced Back (Dorsal) & Sides		⚡	Chest		Shoulders & Back		⚡	⚡	⚡	⚡	OSHA & ANSI Z359.11-2014
Epic	UFH10331P	5	Back (Dorsal) & Sides			⚡ + Chest	⚡	Shoulders & Back	⚡			⚡		OSHA & ANSI Z359.11-2014
Epic	UFH10331G	5	Back (Dorsal) & Sides		⚡	Chest	⚡	Shoulders & Back	⚡			⚡		OSHA & ANSI Z359.11-2014
Epic+	UFH10332P	5	Enhanced Back (Dorsal) & Sides			⚡ + Chest	⚡	Shoulders & Back		⚡	⚡	⚡	XL-2X, 2X-3X	OSHA & ANSI Z359.11-2014
Epic+	UFH10332G	5	Enhanced Back (Dorsal) & Sides		⚡	Chest	⚡	Shoulders & Back		⚡	⚡	⚡	XL-2X, 2X-3X	OSHA & ANSI Z359.11-2014
Epic+	UFH10341G	5	Enhanced Back (Dorsal), Front & Sides		⚡	Chest	⚡	Shoulders & Back		⚡		⚡		OSHA & ANSI Z359.11-2014
Element	UFH10801GQ	5, Revolta™ Oil and Water Repellent	Enhanced Back (Dorsal)		⚡	Chest				⚡	⚡	⚡	⚡	OSHA & ANSI Z359.11-2014
Element	UFH10802Q	5, Revolta™ Oil and Water Repellent, Trauma Relief Straps	Enhanced Back (Dorsal)			⚡ + Chest		Removable Shoulders & Back		⚡	⚡	⚡	⚡	OSHA & ANSI Z359.11-2014
Element	UFH10811GQ	5, Revolta™ Oil and Water Repellent	Enhanced Back (Dorsal), Front		⚡	Chest				⚡	⚡	⚡	⚡	OSHA & ANSI Z359.11-2014
Element	UFH10700P	5 Arc Flash Rated	Back (Dorsal)	⚡					⚡			⚡		OSHA & ANSI Z359.11-2014
Element	UFH10701P	5 Arc Flash Rated	Back (Dorsal) & Sides	⚡					⚡			⚡		OSHA & ANSI Z359.11-2014
Element	UFH1071CP	5 Arc Flash Rated	Back (Dorsal), Front	⚡					⚡			⚡		OSHA & ANSI Z359.11-2014
Element	UFH10711P	5 Arc Flash Rated	Back (Dorsal), Front Web Loops	⚡					⚡			⚡		OSHA & ANSI Z359.11-2014
Element	UFH10731P	5 Arc Flash Rated	Back (Dorsal) & Sides	⚡			⚡	Removable Shoulders & Back	⚡			⚡		OSHA & ANSI Z359.11-2014
Element	UFH10732P	5 Arc Flash Rated	Back (Dorsal), Front & Sides	⚡			⚡	Removable Shoulders & Back	⚡			⚡		OSHA & ANSI Z359.11-2014

*Arriving Q1-2023

BODY WEAR

Harness Sizing Chart

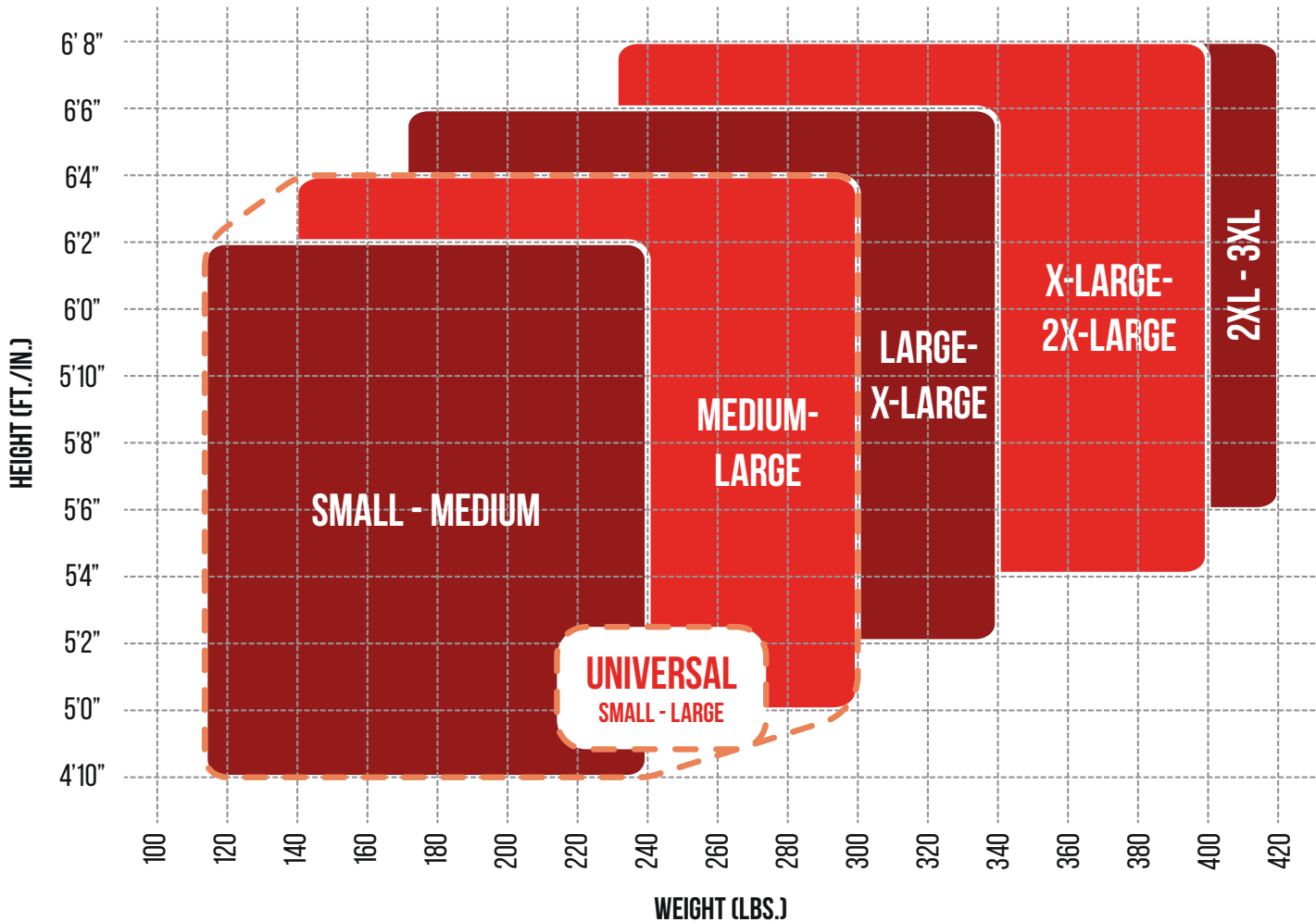

Harness & Lanyard Combo Kits

UFK10010(S-L) | 3pt. FBH, MB Legs, and 6 Internal SAL with Snap Hooks Size: S-L
 UFK10010(L-XL) | 3pt. FBH, MB Legs, and 6 Internal SAL with Snap Hooks Size: L-XL

UFK10015(S-L) | 3pt. FBH, MB Legs, and 6 Internal SAL with Loop & Snap Hook Size: S-L
 UFK10015(L-XL) | 3pt. FBH, MB Legs, and 6 Internal SAL Loop & Snap Hook Size: L-XL

UFK10025(S-L) | 3pt. FBH, MB Legs, and 6 Internal SAL Twin Leg 100% Tie Off with Loop & Rebar Hooks Size: S-L
 UFK10025(L-XL) | 3pt. FBH, MB Legs, and 6 Internal SAL Twin Leg 100% Tie Off with Loop & Rebar Hooks Size: L-XL



BODY WEAR

Harness & Lanyard Combo Kits

UFK20010(S-M) | 5pt. FBH, MB Legs, and 6 Internal SAL with Snap Hooks Size: S-M
UFK20010(M-L) | 5pt. FBH, MB Legs, and 6 Internal SAL with Snap Hooks Size: M-L
UFK20010(L-XL) | 5pt. FBH, MB Legs, and 6 Internal SAL with Snap Hooks Size: L-XL



UFK20015(S-M) | 5pt. FBH, MB Legs, and 6 Internal SAL with Loop & Snap Hook Size: S-M
UFK20015(M-L) | 5pt. FBH, MB Legs, and 6 Internal SAL with Loop & Snap Hook Size: M-L
UFK20015(L-XL) | 5pt. FBH, MB Legs, and 6 Internal SAL with Loop & Snap Hook Size: L-XL



UFK20025(S-M) | 5pt. FBH, MB Legs, and 6 Internal SAL Twin Leg 100% Tie Off with Loop & Rebar Hooks Size: S-M
UFK20025(M-L) | 5pt. FBH, MB Legs, and 6 Internal SAL Twin Leg 100% Tie Off with Loop & Rebar Hooks Size: M-L
UFK20025(L-XL) | 5pt. FBH, MB Legs, and 6 Internal SAL Twin Leg 100% Tie Off with Loop & Rebar Hooks Size: L-XL



Harness & Lanyard Aerial Kits

UFK20410(S-L) | Aerial Kit with 3pt. FBH, MB Legs, and 4.5- 6ft. Adjustable WPL with Snap Hooks Size: S-L
UFK20410(L-XL) | Aerial Kit with 3pt. FBH, MB Legs, and 4.5- 6ft. Adjustable WPL with Snap Hooks Size: L-XL



UFK20510(S-M) | Aerial Kit with 5pt. FBH, TB Legs, and Micron™ 6ft. SRL with Snap Hook Size: S-M
UFK20510(M-L) | Aerial Kit with 5pt. FBH, TB Legs, and Micron™ 6ft. SRL with Snap Hook Size: M-L
UFK20510(L-XL) | Aerial Kit with 5pt. FBH, TB Legs, and Micron™ 6ft. SRL with Snap Hook Size: L-XL
UFK20510(XL-2XL) | Aerial Kit with 5pt. FBH, TB Legs, and Micron™ 6ft. SRL with Snap Hook Size: XL-2XL
UFK20510(2XL-3XL) | Aerial Kit with 5pt. FBH, TB Legs, and Micron™ 6ft. SRL with Snap Hook Size: 2XL-3XL



UFK23110(S-M) | Aerial Bucket Kit with 5pt. FBH, TB Legs, and 6 Clear Pack SAL with Snap Hooks Size: S-M
UFK23110(M-L) | Aerial Bucket Kit with 5pt. FBH, TB Legs, and 6 Clear Pack SAL with Snap Hooks Size: M-L
UFK23110(L-XL) | Aerial Bucket Kit with 5pt. FBH, TB Legs, and 6 Clear Pack SAL with Snap Hooks Size: L-XL



CONNECTORS

KStrong's extensive selection of connectors for fall arrest, work positioning and restraint applications is built on years of dependable construction, performance and quality through rigorous testing to provide your crew with ultimate protection. When you need to be connected, KStrong has the right equipment for the job!

Model	Length	Shock Absorption	Description
A UFL204101	6ft.	Internal	Snap Hooks
B UFL204111	6ft.	Internal	Snap Hook & Rebar Hook

Model	Length	Shock Absorption	Description
C UFL204121	6ft.	Internal	Y with Snap Hooks
D UFL204131	6ft.	Internal	Y with Rebar Hooks

Energy Absorbing Lanyards | 6ft. Internal Shock Absorption



CONNECTORS

Model	Length	Shock Absorption	Description
E	UFL206101	4.5- 6ft.	Internal - Elasticated Snap Hooks
F	UFL206111	4.5- 6ft.	Internal - Elasticated Snap Hook & Rebar Hook
G	UFL206121	4.5- 6ft.	Internal - Elasticated Y with Snap Hooks
H	UFL206131	4.5- 6ft.	Internal - Elasticated Y with Rebar Hooks
J	UFL206214	4.5- 6ft.	Internal - Elasticated Aluminum Snap Hook & Rebar Hook
K	UFL206234	4.5- 6ft.	Internal - Elasticated Y with Aluminum Rebar Hooks

Energy Absorbing Lanyards | Elasticated 4.5ft. - 6ft.



CONNECTORS

Model	Length	Shock Absorption	Description
A UFL201101(03)	3ft.	Clear Shock Pack	Snap Hooks
B UFL201101(04)*	4ft.	Clear Shock Pack	Snap Hooks
C UFL201101	6ft.	Clear Shock Pack	Snap Hooks
D UFL201111	6ft.	Clear Shock Pack	Snap Hook & Rebar Hook
E UFL201121(04)*	4ft.	Clear Shock Pack	Y with Snap Hooks
F UFL201121	6ft.	Clear Shock Pack	Y with Snap Hooks
G UFL201131	6ft.	Clear Shock Pack	Y with Rebar Hooks
H UFL201421	6ft.	Clear Shock Pack </td <td>Y with Tie-back Hooks</td>	Y with Tie-back Hooks

Energy Absorbing Lanyards | 6ft. Clear Shock Pack



CONNECTORS

Model	Length	Shock Absorption	Description	Model	Length	Shock Absorption	Description
J UFL201301	4.5- 6ft.	Clear Shock Pack	Adjustable with Snap Hooks	L UFL201402	6ft.	Clear Shock Pack	Adjustable 4.5-6' with snap hook and one tie-back hook
K UFL201331	4.5- 6ft.	Clear Shock Pack	Adjustable Y with Rebar Hooks	M UFL201422	6ft.	Clear Shock Pack	Y with Tie-back Hooks & Adjustable D-rings

Energy Absorbing Lanyards | 4.5- 6ft. Adjustable with Clear Shock Pack



J



K

L

M

CONNECTORS

Model	Length	Shock Absorption	Description	Model	Length	Shock Absorption	Description
A UFL201701	6ft.	Shock Pack	Dielectric Arc Flash Rated with Snap & Rebar Hook	C UFL201740*	6ft.	Shock Pack	Dielectric Arc Flash Rated with Snap Hook & Loop
B UFL201721	6ft.	Shock Pack	Y Dielectric Arc Flash Rated with Rebar Hooks	D UFL201750*	6ft.	Shock Pack	Y Dielectric Arc Flash Rated with Rebar Hooks and Loop

Energy Absorbing Lanyards | 6ft. Arc Flash



CONNECTORS

Model	Length	Shock Absorption	Description	Model	Length	Shock Absorption	Description
E UFL201601	6ft.	Clear Shock Pack	LE Rated with Snap Hooks	G UFL201622	6ft.	Clear Shock Pack	LE Rated Y with Rebar Hooks
F UFL201621	6ft.	Clear Shock Pack	LE Rated Y with Snap Hooks				

Energy Absorbing Lanyards | LE Rated for up to 12ft. Free-fall



CONNECTORS

Model	Length	Shock Absorption	Description	Model	Length	Shock Absorption	Description	
A	6ft.	N/A	Snap Hooks	D	UFL205201(02)	2ft.	N/A	Snap Hooks
B	4.5- 6ft.	N/A	Adjustable with Forged Steel Snap Hooks	E	UFL205201(03)	3ft.	N/A	Snap Hooks
C	4.5- 6ft.	N/A	Adjustable with Snap Hooks	F	UFL205401		N/A	WPL Chain Assembly
				G	UFL205251		N/A	WPL Web Assembly

Work Positioning Lanyards & Devices



ANCHORAGES

Selecting an appropriate anchorage connector for your fall arrest system is a critical element in protecting yourself and others from fall hazards. Designed to fit a broad scope of general and specific user applications, our offering of anchorage connectors meets those requirements head-on by providing a secure point of attachment. Fall arrest anchors are identified by what they connect such as steel anchors, concrete anchors, roof anchors and specialty safety anchors designed for your unique applications. Your crew can work with confidence knowing each connector is rigorously tested and meets or exceeds industry standards.

Anchors | Concrete & Steel

UFA30090 | 3/4" Removable Bolt Anchor for Concrete



Concrete Embed Anchor Straps

With Loop and D-Ring



Model	Length
UFA20504	4 ft.
UFA20506	6 ft.

With Loops on Both Ends



Model	Length
UFA21004	4 ft.
UFA21006	6 ft.

UFASWK58 | 10K Swivel Anchor Steel Kit w/ 5/8 x 4" G8 Steel Bolt Lockwasher & Locknut



UFA30050 | Steel weld-on or bolt-on anchor point



UFA30080 | Removable Steel Girder Anchor



UFA30301 | Bolt-on steel two hole d-ring anchor



ANCHORAGES

Roofing Kits

UFB101025(L-XL) - 25ft. Rope | **UFB101050(L-XL)** - 50ft. Rope
Roofers Kit with 5-point Adjustable Harness (size L- XL), 25ft. or 50ft. Vertical 5/8" Diameter Polysteel Lifeline with snap hook on anchor and, other end taped, 3ft. shock absorbing rope grab assembly, reusable hinged roof anchor, storage bucket and lid (ANSI)



UFB201050(L-XL) - Roofers Kit with Elite 5-Point MB Leg Harness Size L-XL, 50ft. Vertical 5/8" Diameter Polysteel Lifeline with snap hook on anchor and, other end taped, 3ft. shock absorbing openable self-tracking rope grab assembly, reusable hinged roof anchor, storage bucket and lid (ANSI)



UFB103050(M-L) - Roofers Kit with Elite 5-Point TB Leg Harness Size M-L, 50ft. Vertical 5/8" Diameter Polysteel Lifeline with snap hook on anchor and, other end taped, 3ft. shock absorbing rope grab assembly, reusable hinged roof anchor, storage bucket and lid (ANSI)



UFB102025(M-L) - Roofers Kit with Elite+ 5-Point TB Leg Harness Size M-L, Trauma Relief Straps, 25ft. Vertical 5/8" Diameter Polysteel Lifeline with snap hook on anchor and, other end taped, 3ft. shock absorbing rope grab assembly, reusable hinged roof anchor, storage bucket and lid (ANSI)



UFB501125(L-XL) - Roofers Boxed Kit with 3-point Adjustable Harness (size L- XL), 25ft. Vertical 5/8" Diameter Polysteel Lifeline with snap hook on anchor end, other end folded with heat shrink cover, 3ft. shock absorbing rope grab assembly, and reusable hinged roof anchor (ANSI).

ANCHORAGES

Roofing Accessories

Polysteel 5/8" Rope
 UFR100025 | 25ft., UFR100050 | 50ft.,
 UFR100100 | 100ft., UFR100200 | 200ft.,
 UFR100500 | 500ft.



White Polydac Rope
 UFR200025 | 25ft., UFR200050 | 50ft.,
 UFR200100 | 100ft., UFR200200 | 200ft.,
 UFR200500 | 500ft.



White Polydac Rope w/2 Snap Hooks
 UFR210025 | 25ft., UFR210050 | 50ft.,
 UFR210100 | 100ft., UFR210200* | 200ft.



UFX903050* | Rope Termination Anchor



UFG602100* | 5/8" Stainless Steel Self-Tracking Rope Grab with Roller Guide



UFG601010 | Anti-panic Self-tracking Rope Grab for 5/8" Rope



UFG611020 | Manual 3ft. Shock Absorbing Rope Grab Assembly



UFG611010 | 3 Self tracking non-captive openable shock absorbing rope grab assembly. For use on 5/8" rope.



UFA30015 | Single Use Steel, Raised
 UFA30015N | Single Use Steel, Raised w/8Nails



UFA30020 | Permanent Use Stainless Steel Roof Anchor with D-rings



UFA30001 | Hinged Reusable



UFA30010 | Single Use Steel



UFA30021* | Permanent Use Stainless Steel 17" Roof Anchor with 1 Forged D-ring



ANCHORAGES

Additional Roof Anchors

Riser Post Roof Anchor for Concrete Decks
 UFA55207SW(12) - 12'
 UFA55207SW(18) - 18'

End Post for Fixed Systems
 UFA55207E(12) - 12'
 UFA55207E(18) - 18'

UFA000WT | Wood Truss Anchor /1,800bf

UFA30005* | Reusable heavy duty chain roof anchor

UFA30211 | Stand Alone Post for SRL on Standing Trapezoidal Metal Roof Deck; 360° rotation



UFA30201 | Stand Alone Post for SRL on Standing Seam Metal Roof Deck; Seam Widths Ranging from 24" - 36"; 360° rotation

UFA30201S* | Steel Swivel Roof Anchor for Self-Retracting Lifeline Used on Standing Seam Metal Roof Deck 16-24"



UFA55370 | Single Seam Roof Anchor

UFA30070 | Parapet Anchor Clamp with Extended Movable Arm



ANCHORAGES

Specialty Anchor

UFA30430 - Vertical Post for Containers

- anchor for working on top of 20ft. - 40ft. shipping containers.
- container depending upon the requirement of work to be done
- Comes with a side lock and tagline arrangement for easy and secure installation that can be performed by one person
- connections as anchor points
- safe transportation
-

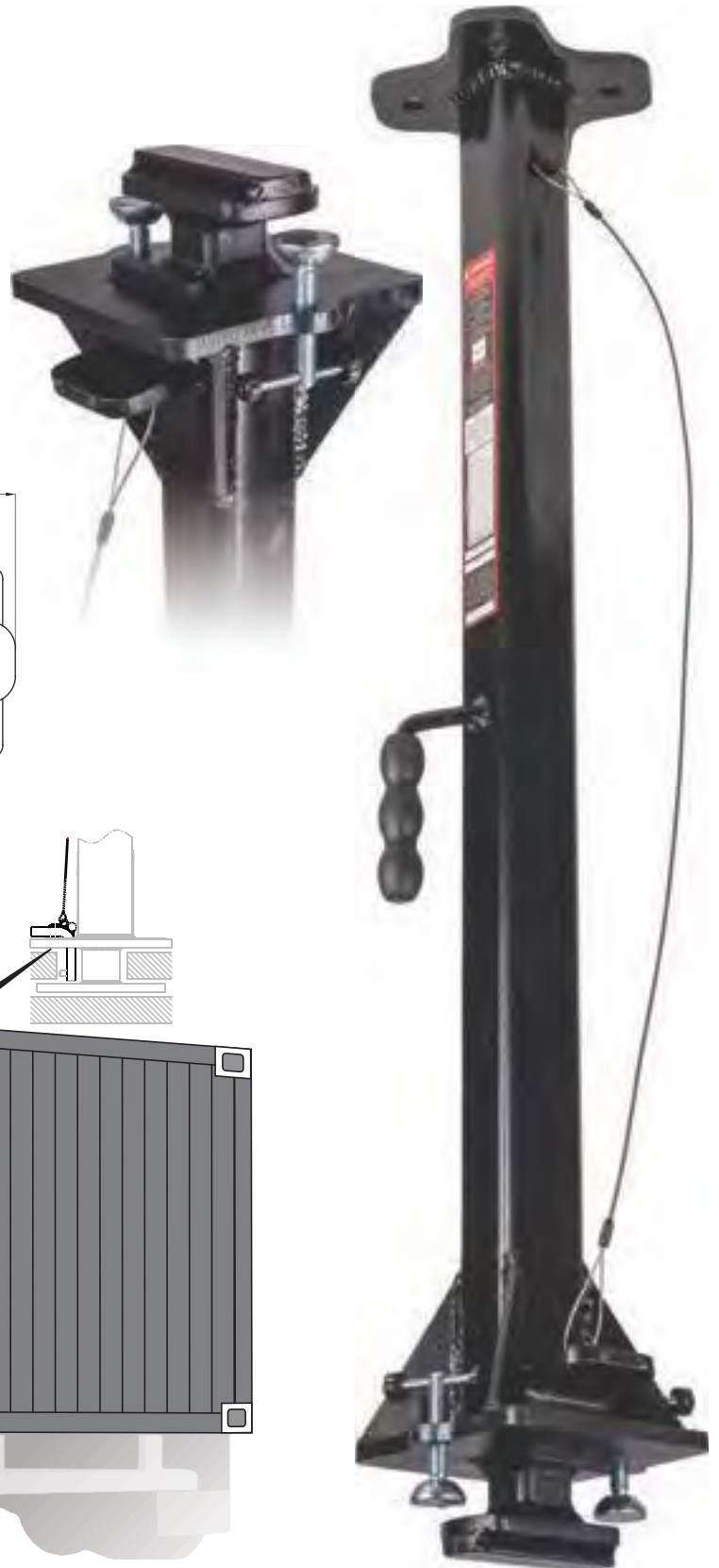
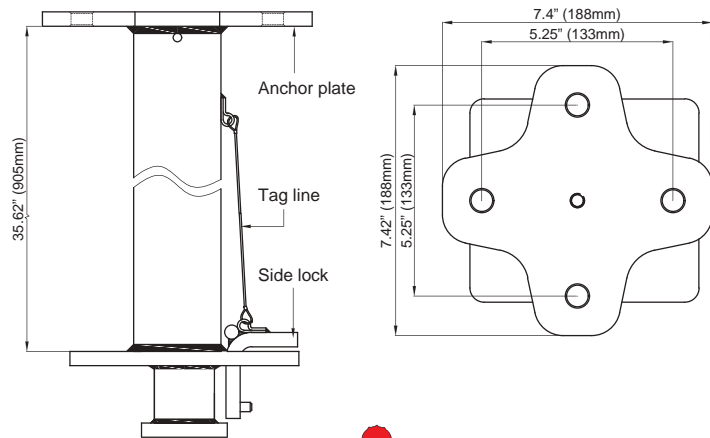

ANCHORAGES

Anchors | I-beam

UFA30110 | I-beam anchor, Adjustable to fit flange widths of 3.5" to 14"



UFA30115 | I-beam anchor, Adjustable to fit flange widths of 3.5" to 6"



UFA30130 | Aluminum and Steel Rolling Beam Anchor, adjustable 3.14" - 9.84"



ANCHORAGES

Multipurpose Anchors | Web Slings

Choker Style Anchor Strap with Wear Pad

Model	Length
UFA20003	3ft.
UFA20004	4ft.
UFA20006	6ft.
UFA20010	10ft.
UFA20016	16ft.
UFA20024	24ft.
UFA20030	30ft.



Anchors | Wire Cable Slings

Wire Cable Sling, large and small O-rings



Model	Length
UFA710103	3ft.
UFA710104	4ft.
UFA710106	6ft.

Wire Cable Sling with snap hook and large O-ring



Model	Length
UFA710003	3ft.
UFA710004	4ft.
UFA710006	6ft.

Anchors | Drop Thru

UFA30501 | 5K Drop Thru Anchor with Swivel D-ring- 4" Round Plate with 6' Cable
 UFA30501(04) | 5K Drop Thru Anchor with Swivel D-ring- 4" Round Plate with 4' Cable



*Arriving Q1-2023

ANCHORAGES

Door Jamb/Window Anchor

UFA30401 | Door Jamb/Window Anchor, adjustable 23.6" - 49.2"

- KStrong Door Anchor provides a non-intrusive anchor point and can be easily installed inside the interior of a building or window opening enabling the most difficult jobs to get done safely and with confidence.
- KStrong Door Anchor can be installed by just compressing it against the door or window frame, jamming itself between the two vertical sides.
- It is constructed of Aluminum alloy, hence it is highly corrosion resistant and is lightweight, weighing less than 10.7 lbs.
- The arms of the KStrong Door Anchor are adjustable enabling installation on door/window frames of width from 23.62" to 49.21".
- Fast and easy Installation with built in adjustment knob hence no tools or drilling is required.
- Extremely portable design for easy transport, storage and usage. Every Door Anchor is provided with a deluxe carrying bag.



**60 FT.
ADJUSTABLE**
HANDY LINE™
2-PERSON TEMPORARY HORIZONTAL LIFELINE

UFA40110 | KStrong® Handy Line™ 60ft. Adjustable
2-Person Temporary Horizontal Lifeline System

*Arriving Q1-2023

ADDITIONAL PRODUCTS

In addition to anchorages, body wear, connectors and devices, KStrong, also provides fall protection solutions for Confined Space Entry, Horizontal Lifeline systems, plus our evolving selection of Dropped Tool Prevention solutions.

Horizontal System

UFA40010 | KStrong® Wrangler™ 100 ft. Adjustable 4-Person Capacity Lightweight Quick Set-up Horizontal Lifeline System. Includes installation carabiner at each end, tension indicator, and two (2) UFA20006 6 ft. anchor straps.

**100 FT.
ADJUSTABLE**
WRANGLER™
4-PERSON TEMPORARY HORIZONTAL LIFELINE



UFA40012 | KStrong® Wrangler Jr.™ 60 ft. Adjustable 2-Person Capacity

**60 FT.
ADJUSTABLE**
WRANGLER JR.™
2-PERSON TEMPORARY HORIZONTAL LIFELINE



ADDITIONAL PRODUCTS

Rescue and Descent



Dual Built-in Pulley Head Assembly

Model	Description
A UFT510010	10ft. Adjustable Height Tripod with Dual Built-in Pulley Head Assembly
B UFT510007	7ft. Adjustable Height Tripod with Dual Built-in Pulley Head Assembly
C UFT530060	60ft. Wnch
D UFT531130	100ft. Wnch
E UFS310060R	BRUTE™ 60ft. 3-way SRL-R
F UFS310100R	BRUTE™ 100ft. 3-way SRL-R
G UFT510010B	Mounting Bracket for 3-way SRL
No Pic UFT510010B2	Universal Lower Assembly Mounting Bracket Receiver for Wnch and 3-Way Rescue/Retrieval Device Brackets
H UFX903010*	Spreader Bar with Snap Hooks (ANSI)
J UFZ810020*	10ft. Megapod™ Storage Bag
K UFZ810010*	7ft. Megapod™ Storage Bag
Kit UFT510010DK	10ft. Deluxe Kit. Includes Tripod, 60ft. 3-way Rescue Retrieval SRL-R with Mounting Bracket, 60ft. Material /Personnel Wnch, and Storage Bags for Tripod /Equipment.
Kit UFT510010BK	10ft. Basic Kit. Includes Tripod, 60ft. Material /Personnel Wnch, and Storage Bags for Tripod /Wnch.

ADDITIONAL PRODUCTS

Rescue and Descent Davits



Model	Description
A UFT55101DK	Megadavit™ H-Base Deluxe Kit. Includes H-Base Frame Assembly, 54 in. Column Mast, 3 ft. Cantilever Boom Arm with Winch Bracket, 60 ft. 3-way Rescue Retrieval SRL-R with Mounting Bracket, and 60 ft. Material /Personnel Winch
UFT55101BK	Megadavit™ H-Base Basic Kit. Includes H-Base Frame Assembly, 54 in. Column Mast, and 3 ft. Cantilever Boom Arm with Winch Bracket
B UFT555001	Megadavit™ H-Base Frame Assembly (High Strength Aluminum Alloy)
C UFT556201	Megadavit™ 54 in. Column Mast (High Strength Aluminum Alloy)
D UFT556101	Megadavit™ 36 in. Column Mast (High Strength Aluminum Alloy)
E UFT556001	Megadavit™ 3 ft. Cantilever Boom Arm with Winch Bracket (High Strength Aluminum Alloy)
F UFT555101	Megadavit™ Floor Mount Column Mast Receiver (SS316)
G UFT555201	Megadavit™ Wall Mount Column Mast Receiver (SS316)
H UFT555002	Megadavit™ Concrete Embed Column Mast Receiver (SS316)



*Arriving Q1-2023

ADDITIONAL PRODUCTS

Rescue and Descent Davits



Model	Description
J UFT551080DK	Side Entry Davit Assembly Deluxe Kit with 60ft. 3-way Rescue Retrieval SRL-R with Mounting Bracket
UFT551080	Side Entry Davit Assembly with Retrieval Device Bracket (High Strength Aluminum Alloy)
K UFT551021DK	Megadavit™ Floor Mount Deluxe Kit. Includes Floor Mount Column Mast Receiver, 54 in. Column Mast, 3ft. Cantilever Boom Arm with Winch Bracket, 60ft. 3-way Rescue Retrieval SRL-R with Mounting Bracket, and 60ft. Material /Personnel Winch
UFT551021BK	Megadavit™ Floor Mount Basic Kit. Includes Floor Mount Column Mast Receiver, 54 in. Column Mast, and 3ft. Cantilever Boom Arm with Winch Bracket
L UFT551031DK	Megadavit™ Wall Mount Deluxe Kit. Includes Wall Mount Column Mast Receiver, 54 in. Column Mast, 3ft. Cantilever Boom Arm with Winch Bracket, 60ft. 3-way Rescue Retrieval SRL-R with Mounting Bracket, and 60ft. Material /Personnel Winch
UFT551031BK	Megadavit™ Wall Mount Basic Kit. Includes Wall Mount Column Mast Receiver, 54 in. Column Mast, and 3ft. Cantilever Boom Arm with Winch Bracket

CONNECTORS

Carabiners

UFC401100 | Steel Carabiner with .84" gate opening



UFC401110 | Small Steel Carabiner with 1" gate opening



UFC408120 | Steel Carabiner with 2" gate opening



UFC408450 | Large Aluminum Rebar Hook with 2" gate opening



UFC401400 | Aluminum Bulb Type Carabiner with .67" gate opening



UFC401101 | Oval Steel Carabiner with .67" gate opening



UFC404450 | Small aluminum quarter turn locking carabiner with swivel load indicator



UFC404500 | Steel Swivel Snap hook with load indicator



UFC404150 | Stamped Steel Snap Hook



UFC405100 | Tie-back snap hook with 5000lb. rated gate.



UFC408100* | Large rebar hook, stamped - 2.63" opening



DROP PREVENTION

Kaptor™ Drop Prevention

DL100021 | Locking Single Carabiner - 22 lbs. ANSI Rated



DL100022 | Dual Leg Locking Single Carabiner - 22lbs. ANSI Rated



DA300411 | Wrist Tool Lanyard - 2lbs.



DA300401 | Pull-On Wrist Lanyard with Buckle - 3lbs.



DA300201 | Small Tool/ Radio Holster



DA300301 | Tape Measure Trap



DA300101 | Elastic Hard Hat Lanyard w/ Clamp - 2lbs.



DT700101 | Self-Adhering Tape Trap - 12 ft. Roll



KAPTOR™

DROP PREVENTION



DROP PREVENTION

Kaptor™ Kits

DK400101 | Tool Tethering Kit - 5lbs. Consists of DL100201 in standard pack of 3, DL100401 in standard pack of 1, DT700101 in standard pack of 1



Tool Tethering Kits (DT700101 and DL100501 plus corresponding Web Tool Tail)

DK400151(S) | Web Tool Tail, 3lbs. S - 2.5inches



DK400152(M) | Web Tool Tail, 3lbs. M - 4.5inches



DK400153(L) | Web Tool Tail, 3lbs. L - 5.5inches



DK400154(XL) | Web Tool Tail, 3lbs. XL - 6.5inches



DK400201 | Tape Measure Coil Tethering Kit - 2lbs. Consists of DL100501 & DA300301 in standard pack



DK400301 | Tape Measure Lanyard Tethering Kit - 2lbs. Consists of DL100401 & DA300301 in standard pack



DK400155(2XL) | Web Tool Tail, 3lbs. 2XL - 8.5inches



DROP PREVENTION

Kaptor™ Tool Lanyards

UDL100012 | Dual Leg - 10lbs.



DL100021 | Locking Single Carabiner - 22 lbs. ANSI Rated



DL100022 | Dual Leg Locking Single Carabiner - 22lbs. ANSI Rated



DL100041 | Tool Lanyard Single Carabiner with Web Loop - 22lbs.



DL100042 | Dual Leg Tool Lanyard Single Carabiner with Web Loops - 22lbs.



DL100701 | Hook to Loop Bungee Tool Tether - 35lbs.



DL100711 | Hook 2Loop Tool Tether, Heavy Duty - 80lbs.



DL100501 | Coiled Cable Lanyard - 2lbs.



DL100601* | Clip 2 Loop Coil Tether, 10 Pack



10-Pack

DL100801 | Wire Loop Tool Tail - 2lbs. (6Pack)



6-Pack

DL100802 | Wire Screw Gate Tool Tail - 3 lbs. (6Pack)



6-Pack

DL100401 | Detachable Elasticated Single Screwgate Carabiner - 5lbs.



DL100400 | Detachable Elasticated Single Screwgate Carabiner (without Loop) - 5lbs.



DL100201 | Accessory Kit - Detachable Loops 3-pack



3-Pack

DL100611 | D-Ring with Cord Loop, Attachment Points 10pack



10-Pack

DROP PREVENTION

Kaptor™ Tool Lanyards

DL100101 | Elastic Loop Tool Tails Ext - 15 lbs. 3-pack



3-Pack

DL100151 | Elastic Loop Tool Tails Swivel - 10lbs. 3-pack



3-Pack

DL100301 | Web Tool Tails, 3lbs. 6Pack S - 25inches



6-Pack

DL100302 | Web Tool Tails, 3lbs. 6-Pack M - 4.5inches



6-Pack

DL100303 | Web Tool Tails, 3lbs. 6Pack L - 5.5inches



6-Pack

DL100304 | Web Tool Tails, 3lbs. 6Pack XL - 6.5inches



6-Pack

DL100305 | Web Tool Tails, 3lbs. 6Pack 2XL - 8.5inches



6-Pack

DL100351 | Web Tool Tails with Swivel, 3 lbs. 6pack S - 25inches



6-Pack

DL100352 | Web Tool Tails with Swivel, 3 lbs. 6-pack M - 4.5inches



6-Pack

DL100353 | Web Tool Tails with Swivel, 3 lbs. 6-pack L - 5.5inches



6-Pack

DL100354 | Web Tool Tails with Swivel, 3 lbs. 6-pack XL - 6.5inches



6-Pack

DL100355 | Web Tool Tails with Swivel, 3 lbs. 6-pack 2XL - 8.5inches



6-Pack

DL200301 | Tool Cinch, Medium Duty, 35 lbs.



DL200311 | Tool Cinch, Single Wing, Medium Duty, 35lbs.



DL200101 | Tool Cinch, Dual Wing, Medium Duty, 35lbs.



DL200201 | Tool Cinch, Dual Wng, Medium Duty, 80lbs.



*Arriving Q1-2023

ADDITIONAL PRODUCTS

Ladder Rescue System

UFR1018B | 18ft. ladder with belay system



Ladder Climbing System for Fixed Ladders

- using appropriate mounting brackets.
- UFG602050 locks them in case of fall.

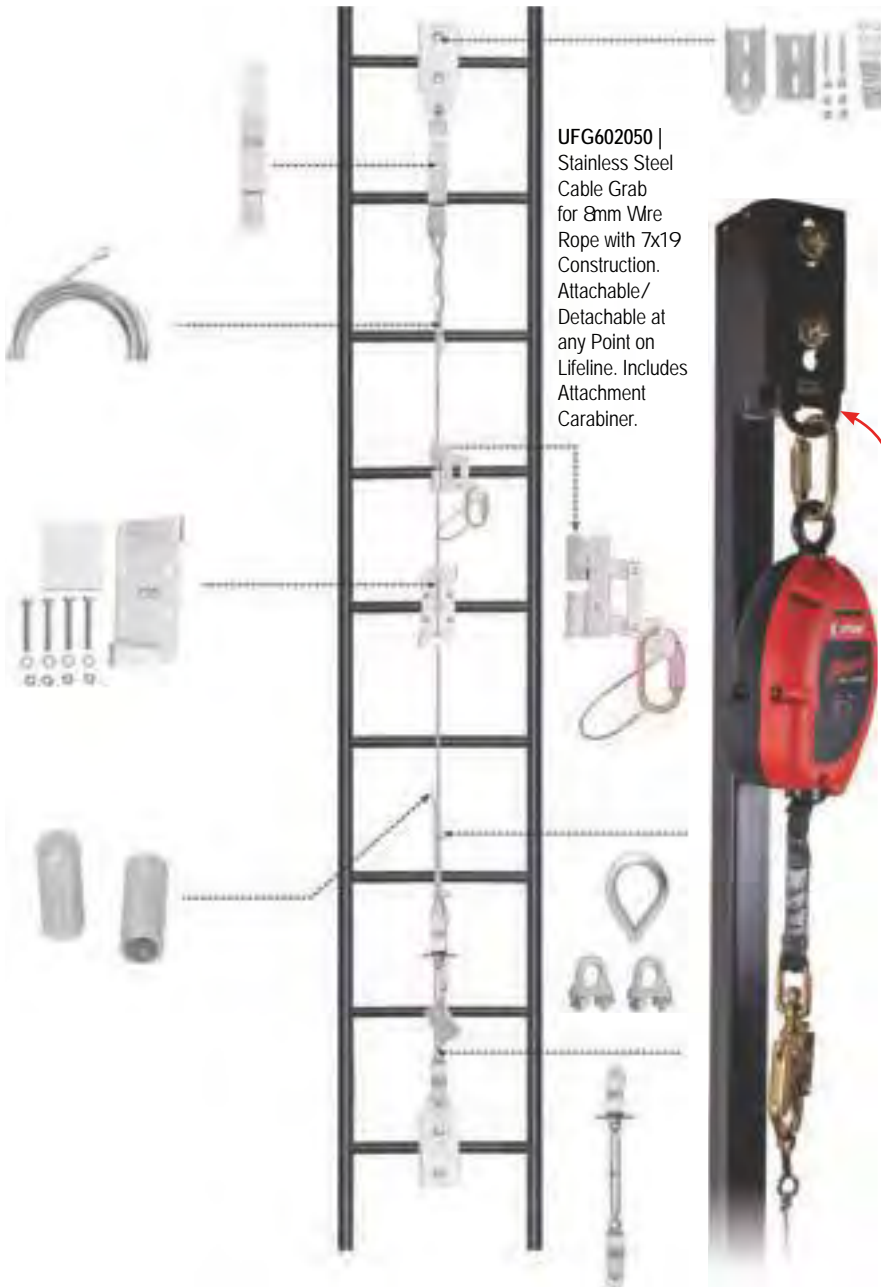

UFG602050 | Stainless Steel Cable Grab for 8mm Wire Rope with 7x19 Construction. Attachable/Detachable at any Point on Lifeline. Includes Attachment Carabiner.

UFF516000
KStrong® Ladder
Extension Davit Kit for
Fixed Ladders

Model	Length	Model	Length
USCLC020	20ft.	USCLC080	80ft.
USCLC030	30ft.	USCLC090	90ft.
USCLC040	40ft.	USCLC100	100ft.
USCLC050	50ft.	USCLC130	130ft.
USCLC060	60ft.	USCLC160	160ft.
USCLC070	70ft.	USCLC200	200ft.



THIS. IS. A. GAME CHANGER!

Your KStrong® fall protection gear just got an upgrade like no other.

KStrong Compass™ is a cloud-based software app which relieves the user from a mountain of paper records. The unique AIR system (Automated Inspection Reminder system) reminds a user of a pending competent person inspection that is required to minimize accidents that may happen due to equipment that has not been properly inspected.



Watch Demo Inspection Video
Scan with Camera



Compass™ Product Example
Scan with Camera

Compass™ Features

Introducing KStrong Compass™, the fall protection industry's first "free at your fingertips" mobile application for fall protection equipment asset management.

Pre-Use Inspection Instructions

The mobile app provides each user vital information on inspection and periodic maintenance needs and helps in increasing the life of the equipment.

Get Tech Data & Manuals

User Instruction Manuals, Technical Data Sheets, Declarations of Conformity, Product Images, Videos, PowerPoint presentations and more are available.

Track Usage

The KStrong Compass™ user management system allows equipment to be issued to individuals, thus ensuring accountability towards the upkeep of the equipment.



Use in the Field

If you have an iOS or ANDROID phone or device, that is all you need. Simply open the camera on your phone or device and scan the QR code, Label or RFID tag that is included with every KStrong product.



Get Reminders

The unique AIR system (Automated Inspection Reminder) reminds a user of a pending competent person inspection that is required to minimize accidents due to equipment that has not been properly inspected.

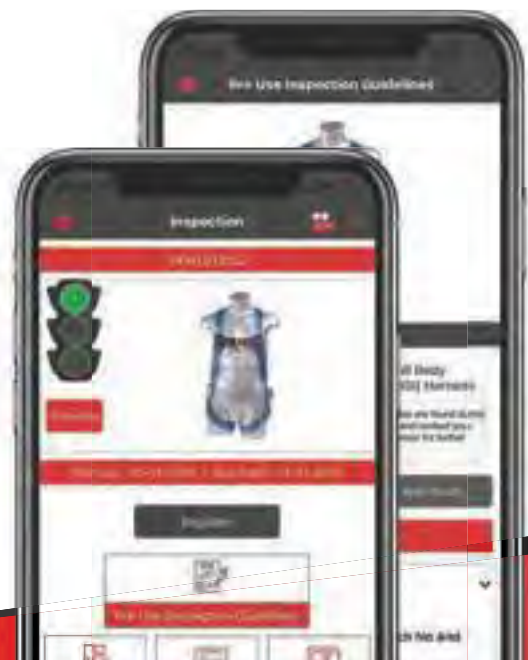

QUICK INDEX

Part Number	Page No.	Part Number	Page No.	Part Number	Page No.	Part Number	Page No.	Part Number	Page No.	Part Number	Page No.	Part Number	Page No.
DA300101	50	UFA20004	43	UFB102025	38	UFH10731P	25	UFL205201	36	UFS319006L	11	UFT556201	47
DA300201	50	UFA20006	43	UFB103050	38	UFH10732P	25	UFL205201(02)	36	UFS319006LD	11	UFX903010	46
DA300301	50	UFA20010	43	UFB201050	38	UFH10801GQ	23	UFL205201(03)	36	UFS330008	4	UFX903050	39
DA300401	50	UFA20016	43	UFB501125	38	UFH10802Q	23	UFL205211	36	UFS350002	3	UFZ200101	19
DA300411	50	UFA20024	43	UFC401100	49	UFH10811GQ	23	UFL205215	36	UFS350002D	3	UFZ800100	19
DK400101	51	UFA20030	43	UFC401101	49	UFH15201GQ	20	UFL205251	36	UFS350011	6	UFZ800200	19
DK400151	51	UFA20504	37	UFC401110	49	UFH15201Q	21	UFL205401	36	UFS350025	6	UFZ800501	19
DK400152	51	UFA20506	37	UFC401400	49	UFH15203GQ	20	UFL206101	31	UFS351102	3	UFZ801001	19
DK400153	51	UFA21004	37	UFC404150	49	UFH15231GQ	21	UFL206111	31	UFS351102D	3	UFZ801011	19
DK400154	51	UFA21006	37	UFC404450	49	UFH15231Q	21	UFL206121	31	UFS354002	3	UFZ801012	19
DK400155	51	UFA30001	39	UFC404500	49	UFH16101G	14	UFL206131	31	UFS354002D	3	UFZ802001	19
DK400201	51	UFA30005	40	UFC405100	49	UFH16201GP	15	UFL206214	31	UFS356002	3	UFZ802011C	19
DK400301	51	UFA30010	39	UFC408100	49	UFH16231GP	15	UFL206234	31	UFS359002D	3	UFZ840010	25
DL100021	50, 52	UFA30015	39	UFC408120	49	UFH152011GQ	21	UFR1018B	54	UFS359002	3	UFZ840020	25
DL100022	50, 52	UFA30020	39	UFC408450	49	UFK10010	28	UFR100025	39	UFS359002D	3	UFZ850100	18
DL100041	52	UFA30021	39	UFC409151	3, 11	UFK10015	28	UFR100050	39	UFS359506	7	USCLC020	54
DL100042	52	UFA30050	37	UFC516005	54	UFK10025	28	UFR100100	39	UFS359506D	7	USCLC030	54
DL100101	53	UFA30070	40	UFG601010	39	UFK20010	29	UFR100200	39	UFS480020	5	USCLC040	54
DL100151	53	UFA30080	37	UFG602050	54	UFK20015	29	UFR100500	39	UFS480020L	9	USCLC050	54
DL100201	52	UFA30090	37	UFG602100	39	UFK20025	29	UFR200025	39	UFS480025L	9	USCLC060	54
DL100301	53	UFA30110	42	UFG611010	39	UFK20410	29	UFR200050	39	UFS480030	5	USCLC070	54
DL100302	53	UFA30115	42	UFG611020	39	UFK20510	29	UFR200100	39	UFS480050	5	USCLC080	54
DL100303	53	UFA30130	42	UFH10101G	14	UFK23110	29	UFR200200	39	UFS480050L	9	USCLC090	54
DL100304	53	UFA30201	40	UFH10101P	14	UFL201101	32	UFR200500	39	UFS570030	12	USCLC0100	54
DL100305	53	UFA30201(S)	40	UFH10102G	15	UFL201101(03)	32	UFR210025	39	UFS570060	12	USCLC0130	54
DL100351	53	UFA30211	40	UFH10102P	15	UFL201101(04)	32	UFR210050	39	UFS5700100	12	USCLC0160	54
DL100352	53	UFA30301	37	UFH10131G	14	UFL201111	32	UFR210100	39	UFT510007	46	USCLC0200	54
DL100353	53	UFA30401	44	UFH10131P	14	UFL201121	32	UFR210200	39	UFT510010	46		
DL100354	53	UFA30430	41	UFH10201G	16	UFL201121(04)	32	UFS310010	4	UFT510010B	46		
DL100355	53	UFA30501	43	UFH10201P	16	UFL201131	32	UFS310018L	8	UFT510010BK	46		
DL100400	52	UFA30501(4)	43	UFH10211G	17	UFL201301	33	UFS310020	4	UFT510010DK	46		
DL100401	52	UFA40010	45	UFH10211P	17	UFL201331	33	UFS310025L	8	UFT530060	46		
DL100501	52	UFA40012	45	UFH10231G	16	UFL201402	33	UFS310030	4	UFT531130	46		
DL100601	52	UFA40110	44	UFH10231P	16	UFL201421	32	UFS310050	4	UFT551011BK	47		
DL100611	52	UFA55207E(12)	40	UFH10251G	17	UFL201422	33	UFS310050L	8	UFT551011DK	47		
DL100701	52	UFA55207E(18)	40	UFH10251P	17	UFL201601	35	UFS310060R	46	UFT551021BK	48		
DL100711	52	UFA55207SW(12)	40	UFH10252P	18	UFL201611	35	UFS310080L	8	UFT551021DK	48		
DL100801	52	UFA55207SW(18)	40	UFH10261G	18	UFL201621	35	UFS310100	4	UFT551031BK	48		
DL100802	52	UFA55370	40	UFH10331G	22	UFL201622	35	UFS310100R	46	UFT551031DK	48		
DL200101	53	UFA710003	43	UFH10331P	22	UFL201701	34	UFS310130	5	UFT551080	48		
DL200201	53	UFA710004	43	UFH10332G	22	UFL201721	34	UFS310150	5	UFT551080DK	48		
DL200301	53	UFA710006	43	UFH10332P	22	UFL201740	34	UFS310206L	11	UFT555001	47		
DL200311	53	UFA710103	43	UFH10341G	23	UFL201750	34	UFS310206LD	11	UFT555002	47		
DT700101	50	UFA710104	43	UFH10700P	24	UFL204101	30	UFS314006L	11	UFT555101	47		
UDL100012	52	UFA710106	43	UFH10701P	24	UFL204111	30	UFS314006LD	11	UFT555201	47		
UFA000WT	40	UFASWK58	37	UFH10710P	24	UFL204121	30	UFS316106L	11	UFT556001	47		
UFA20003	43	UFB101025	38	UFH10711P	24	UFL204131	30	UFS316106LD	11	UFT556101	47		